

# e-scope<sup>®</sup>

green efficiency

The e-scope<sup>®</sup> pocket instrument is lightweight, economical otoscope & ophthalmoscope at a perfect size and weight for you to carry in your pocket all day.



# OVERVIEW

**PRODUCT CHARACTERISTICS** ..... 3

**TECHNOLOGY** ..... 5

**FUNCTIONAL DESCRIPTION** ..... 6

**PRODUCTS** ..... 7

**e-scope® Otoscopes**

**e-scope® Ophthalmoscopes**

**SETS** ..... 9

**SPARES & ACCESSORIES** ..... 10



## POCKET INSTRUMENTS 2.0

# WHITE LIGHT, GREEN TECHNOLOGY

3.7 V LED illumination and conventional alkaline batteries – an almost impossible combination up to now. Not just pie in the sky, but state of the art. The new **e-scope®** is the perfect blend of leading-edge LED technology, more efficient diagnosis and an environment-friendly energy source. Because the **e-scope®** breaks new ground with its world innovation, the IPC (Integrated Power Converter): younger, smarter and greener.

### The innovative potential of the **e-scope®**

- ▶ LED technology for otoscopes and ophthalmoscopes with low-reflection, bright and white light. The pure white light (approx. 5,500 K) ensures colour-neutral illumination in addition to improved colour differentiation, thereby aiding more efficient diagnosis in comparison with halogen or xenon bulbs.



# CENTREPIECES OF THE **e-scope**<sup>®</sup>

## PIONEERING ADVANTAGES



### LED illumination

For uniform illumination of the examination field with pure white light (5500 K). The LED illumination shows colours as they really are. Helpful for efficient diagnostics plus an almost unlimited service life.

### green efficiency

- Low maintenance costs thanks to long LED and battery service lives. Whilst the service life of a xenon light source is only approx. 20 hours, LED burns for at least 20,000 hours, i.e. over 2 years at a go – with **e-scope**<sup>®</sup>, even with two conventional AA batteries.
- Particularly high environment-friendliness, for the newly developed IPC in the **e-scope**<sup>®</sup> always converts the voltage of simple alkaline batteries into the optimum voltage required for LED operation, resulting in battery lives of around 50 operating hours.

Its optimum values in all these fields make the **e-scope**<sup>®</sup> a pioneering pocket instrument for flexible diagnosis.

**Bulb service lives**

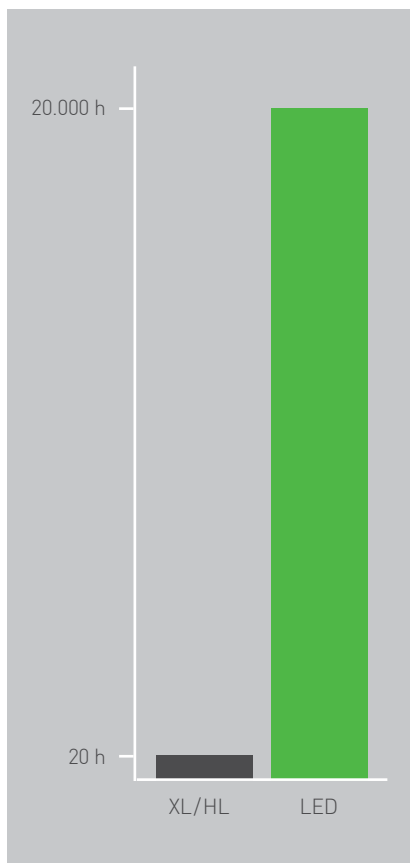

**Battery service lives**

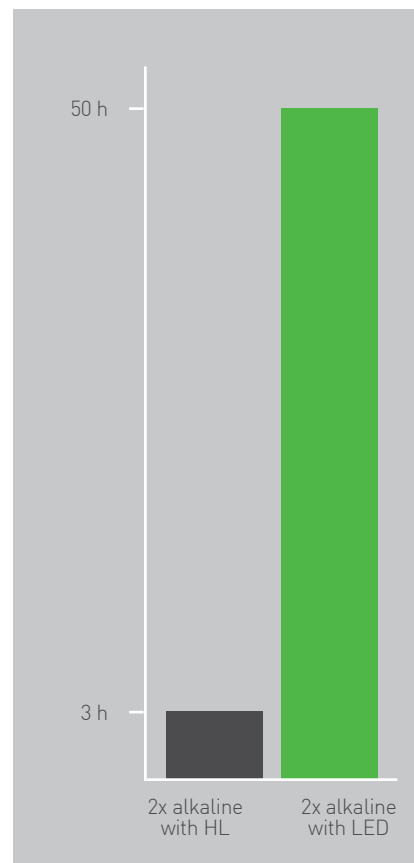

# THE WORLD FIRST IN THE **e-scope®** **2 CM<sup>2</sup> OF SHEER INNOVATION**

AA batteries deliver a maximum 3 V. However, a 3.7 V voltage means that considerably more efficient LEDs can be used. Incompatible technical prerequisites? Not anymore.

With the IPC, Riester has succeeded in producing a development that revolutionises illumination of pocket instruments. Because the tiny IPC inside the **e-scope®** always converts the voltage of conventional AA-size batteries into the optimum voltage supply for LEDs, thereby allowing efficient operation of LED illumination with alkaline batteries.

As a result, the IPC not only allows optimum light quality, but also provides economic and ecological benefits. The service life of a light-emitting diode is therefore up to 1,000 times longer than that of xenon illumination and the batteries used in the **e-scope®** are discharged considerably more thoroughly thanks to the IPC; consequently, they do not need to be disposed of and replaced as often.



▶ Integrated  
Power  
Converter ▶



# e-scope®

## SIMPLY MORE INTELLIGENT

Continuous improvement has always been Riester's claim. With the new e-scope®, a further step has been successfully taken towards optimum illumination, environmentfriendliness and profitability.



- ① 3.7V LED, 2.5V xenon or vacuum illumination
- ② Fibre optics
- ③ 3x magnifying pivoting lens
- ④ Reusable or disposable ear speculum
- ⑤ Pneumatic test connection
- ⑥ On/off switch
- ⑦ Battery compartment and ABS synthetic material casing

- ① 3.7V LED, 2.5V xenon or vacuum illumination
- ② Diptre display
- ③ Diptre adjustment wheel
- ④ Aperture wheel
- ⑤ Spectacle protection
- ⑥ Dust-protected casing

# e-scope® PRODUCT RANGE



e-scope® otoscopes are available with halogen or vacuum direct illumination, F.O. xenon or F.O. LED

- Sealing precision optics pivotable to both sides with triple magnification for optimum view
- Sturdy ear speculum receptacle in hardwearing hygienic metal for e-scope®/ ri-scope® L1/L2 speculum
- Compatible with ear speculae from other renowned manufacturers
- Suitable for performance of pneumatic tests (supplied without connector and insufflator)
- Available in a choice of black or white finish

## e-scope® otoscope with fibre optics (F.O.)

- Economically priced fibre optic version with 2.5 V xenon (3200 K) or innovative 3.7 V LED illumination (5500 K)
- Fibre optics for optimum focusing and guiding of the light

## e-scope® otoscope with direct illumination

- Inexpensive basic model with low-reflection direct illumination with a 2.7 V vacuum bulb (2500 K) or xenon illumination (3000 K)

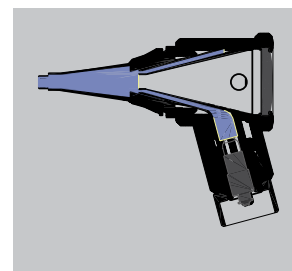

### e-scope® otoscope F.O.

Fibre optics with 2.5 V xenon or 3.7 V LED illumination ensure an unimpeded, free view

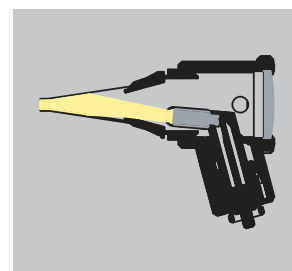

### e-scope® otoscope with direct illumination

Minimised-reflection, economically priced direct illumination with 2.5 V xenon or 2.7 V vacuum illumination

Kelvin data for otoscopes and ophthalmoscopes

LED	Xenon	Halogen	Vacuum
5500 K	3200 K	3000 K	2500 K



# e-scope® PRODUCT RANGE



e-scope® ophthalmoscopes are available with vacuum, xenon or LED illumination.

- With 2.7 V vacuum or 2,5 V xenon illumination and with innovative 3.7 V LED illumination for higher-contrast and more efficient diagnosis
- Dioptre disc with 18 corrective lenses (+/- 1, 2, 3, 4, 6, 8, 10, 15, 20 dioptres)
- Easy-to-use aperture wheel with six different apertures (fixation star, large circle, small circle, red free filter, blue filter, semi circle)
- High performance optics with aspherical condenser lens
- Spectacle protection
- Parallel optical path
- Dust-protected

## Optical path

Corneal and iris reflexes are avoided by separation of the parallel observation and illumination beams (Gullstrand's principle). The illuminated retinal area is fully visible – even with narrow pupils. Optimum conditions are achieved for ophthalmological examinations.

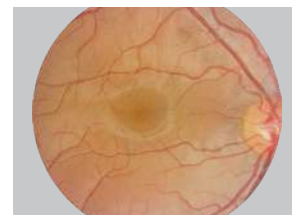
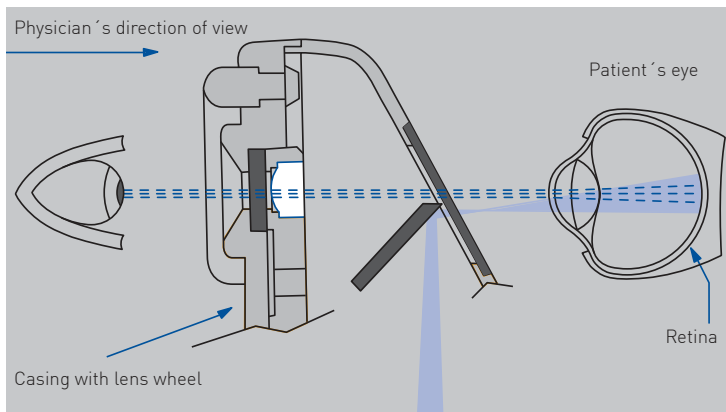

Healthy fundus

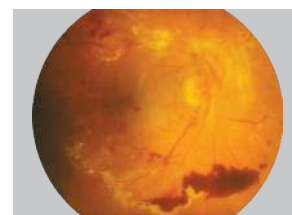

Pathological fundus

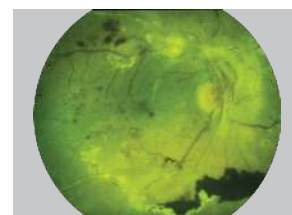

Fundus with red free filter

## Dioptre disc

With 18 corrective lenses

D+ 1 | 2 | 3 | 4 | 6 | 8 | 10 | 15 | 20  
D- 1 | 2 | 3 | 4 | 6 | 8 | 10 | 15 | 20

## Apertures

With easy-to-use aperture wheel

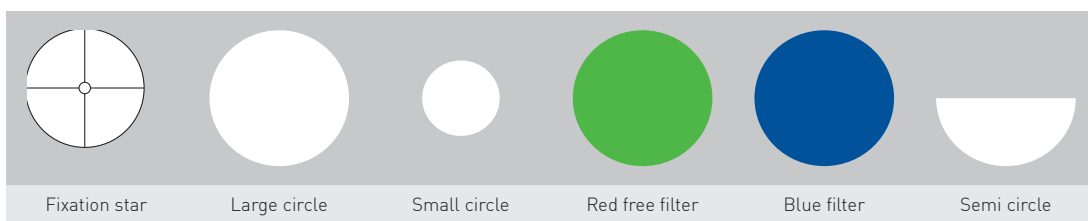



# ALWAYS ON HAND: POCKET-SIZE SETS

## SMALL SETS FOR A HIGH LEVEL OF SAFETY

e-scope® otoscopes and ophthalmoscopes are available in an impact-resistant case or in a space-saving bag. They include special inserts in which the instruments can be perfectly stowed and offer adequate space for the battery handle and ear speculums.



### e-scope® otoscope with direct illumination

- |                          |   |                     |
|--------------------------|---|---------------------|
| ➤ Vacuum 2.7 V, in pouch | <input type="checkbox"/> white            | <b>No. 2100-200</b> |
|                          | <input checked="" type="checkbox"/> black | <b>No. 2101-200</b> |
| ➤ XL 2.5 V, in pouch     | <input type="checkbox"/> white            | <b>No. 2100-201</b> |
|                          | <input checked="" type="checkbox"/> black | <b>No. 2101-201</b> |



### e-scope® F.O. otoscope

- |                      |   |                     |
|----------------------|---|---------------------|
| ➤ XL 2.5 V, in case  | <input type="checkbox"/> white            | <b>No. 2110-202</b> |
|                      | <input checked="" type="checkbox"/> black | <b>No. 2111-202</b> |
| ➤ LED 3.7 V, in case | <input type="checkbox"/> white            | <b>No. 2110-203</b> |
|                      | <input checked="" type="checkbox"/> black | <b>No. 2111-203</b> |



### e-scope® ophthalmoscope

- |                          |   |                     |
|--------------------------|---|---------------------|
| ➤ Vacuum 2.7 V, in pouch | <input type="checkbox"/> white            | <b>No. 2120-200</b> |
|                          | <input checked="" type="checkbox"/> black | <b>No. 2121-200</b> |
| ➤ XL 2.5 V, in case      | <input type="checkbox"/> white            | <b>No. 2122-201</b> |
|                          | <input checked="" type="checkbox"/> black | <b>No. 2123-201</b> |
| ➤ LED 3.7 V, in case     | <input type="checkbox"/> white            | <b>No. 2122-203</b> |
|                          | <input checked="" type="checkbox"/> black | <b>No. 2123-203</b> |



### e-scope® otoscope with direct illumination / ophthalmoscope

- |                          |   |                     |
|--------------------------|---|---------------------|
| ➤ Vacuum 2.7 V, in pouch | <input type="checkbox"/> white            | <b>No. 2130-200</b> |
|                          | <input checked="" type="checkbox"/> black | <b>No. 2131-200</b> |



### e-scope® F.O. otoscope / ophthalmoscope

- |                      |   |                     |
|----------------------|---|---------------------|
| ➤ XL 2.5 V, in case  | <input type="checkbox"/> white            | <b>No. 2130-202</b> |
|                      | <input checked="" type="checkbox"/> black | <b>No. 2131-202</b> |
| ➤ LED 3.7 V, in case | <input type="checkbox"/> white            | <b>No. 2130-203</b> |
|                      | <input checked="" type="checkbox"/> black | <b>No. 2131-203</b> |

# SIMPLE HANDLING

## SPARES AND ACCESSORIES FOR e-scope®



### Reusable ear specula

➤ 2 mm	10 items	<b>No. 10775</b>
➤ 2.5 mm	10 items	<b>No. 10779</b>
➤ 3 mm	10 items	<b>No. 10783</b>
➤ 4 mm	10 items	<b>No. 10789</b>
➤ 5 mm	10 items	<b>No. 10795</b>



### Disposable ear specula

➤ 2 mm	100 items	<b>No. 14061-532</b>
	500 items	<b>No. 14062-532</b>
	1000 items	<b>No. 14063-532</b>
➤ 2.5 mm	100 items	<b>No. 14061-531</b>
	500 items	<b>No. 14062-531</b>
	1000 items	<b>No. 14063-531</b>
➤ 3 mm	100 items	<b>No. 14061-533</b>
	500 items	<b>No. 14062-533</b>
	1000 items	<b>No. 14063-533</b>
➤ 4 mm	100 items	<b>No. 14061-534</b>
	500 items	<b>No. 14062-534</b>
	1000 items	<b>No. 14063-534</b>
➤ 5 mm	100 items	<b>No. 14061-535</b>
	500 items	<b>No. 14062-535</b>
	1000 items	<b>No. 14063-535</b>



### Pneumatic test accessories

➤ Insufflator	<b>No. 10960</b>
➤ Metal connector for the pneumatic test	<b>No. 10961</b>



### Replacement bulbs

➤ for e-scope® F.O. otoscope	XL 2.5 V, pack containing 6 items	<b>No. 10600</b>
	LED 3.7 V	<b>No. 14041</b>
➤ for e-scope® otoscope with direct illumination	Vacuum 2.7 V, pack containing 6 items	<b>No. 10488</b>
	XL 2.5 V, pack containing 6 items	<b>No. 10489</b>
➤ for e-scope® Ophthalmoscope	Vacuum 2.7 V, pack containing 6 items	<b>No. 14050</b>
	XL 2.5 V, pack containing 6 items	<b>No. 10605</b>
	LED 3.7 V	<b>No. 14051</b>

Please visit **riester.de** for more information